

ROPE BUCKET

BIO-RBK-001





ROPE BUCKET

INTRODUCTION

Plantscape Rope Bucket is a freestanding planter wrapped in rope. The rope serves as a structure that holds the greenery. Together they are an abstraction of a path through the jungle.



SND037
PAPER



COR001
FINE ROPE



EXPERIENCE MOVEMENT

Ropes often guide movement. They can be railings on a bridge or support for a swing. Ropes can also guide eyes even when they are stationary. They suggest pathways as they stretch from forest to mountain tops.

ROPE BUCKET

PERSPECTIVE VIEW

Poshfelt® Upholstered Cushion

Fine Rope

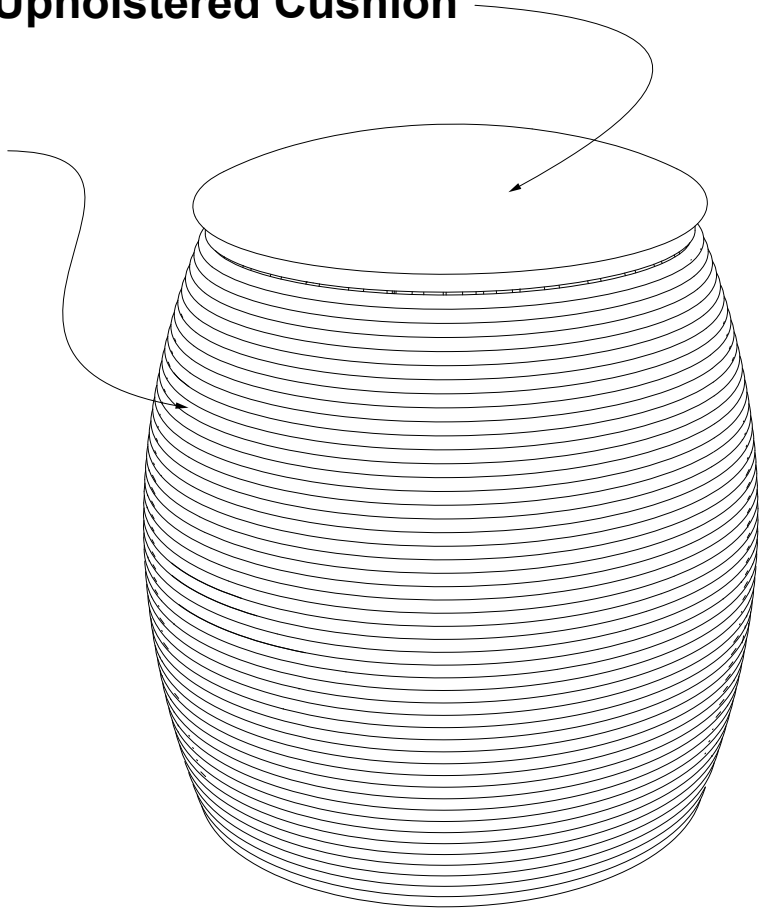

ROPE BUCKET

ELEVATIONS

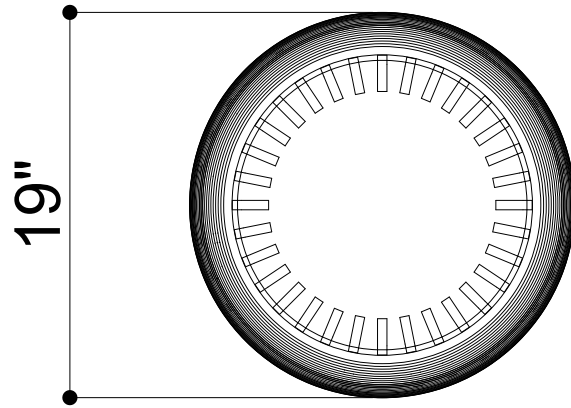

1 TOP VIEW

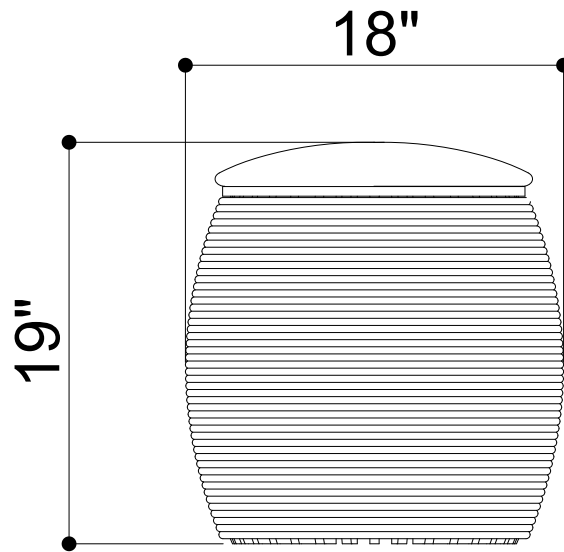

2 FRONT VIEW

ROPE BUCKET

CONFIGURATIONS

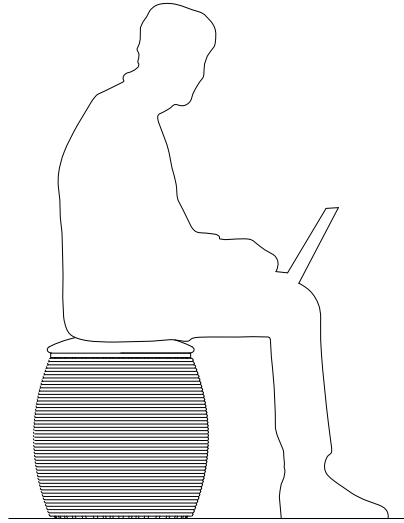

1 CONFIGURATION 1

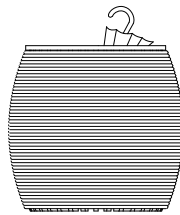

2 CONFIGURATION 2

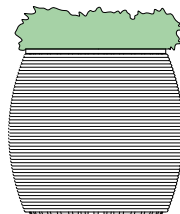

3 CONFIGURATION 3

ROPE BUCKET

GREENERY CONFIGURATIONS

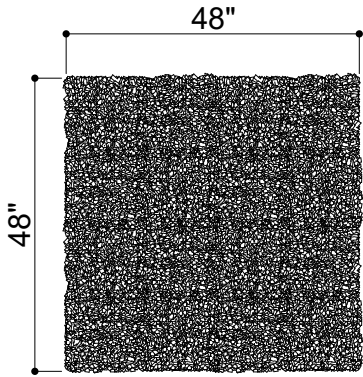

Trimmed 100% Density

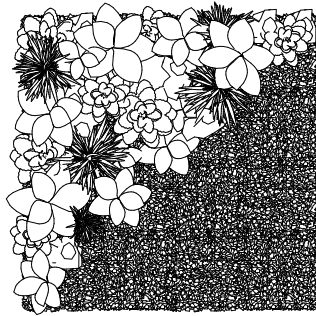

Lush 50% Density

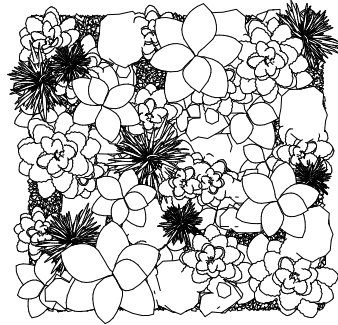

Lush 100% Density

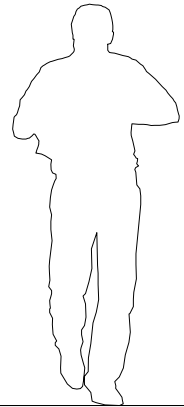

Trimmed 100% Density



Lush 50% Density



Lush 100% Density

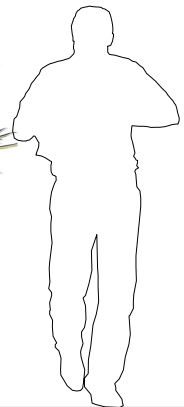

ROPE BUCKET

THERMALEAF® FOLIAGE SYSTEMS

We offer foliage systems for every project and environment type, ranging from live plants to preserved options, to long-lasting replica greenery. Interior vegetation must pass strict fire codes, and ThermoLeaf® greenery ensures fire code compliance as the safest commercially available foliage - that means complete design flexibility with guaranteed feasibility.



REPLICA GREENERY

Replica greenery is the most versatile indoor foliage system, with a massive variety of plant types that can be mixed and matched regardless of atmospheric conditions.

- VARIETY ● ● ● ● ●
- DURABILITY ● ● ● ● ●
- INITIAL COST ● ● ● ● ○
- ONGOING COSTS ● ○ ○ ○ ○

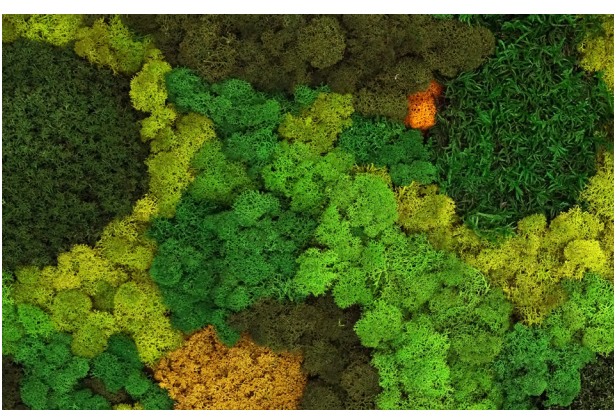
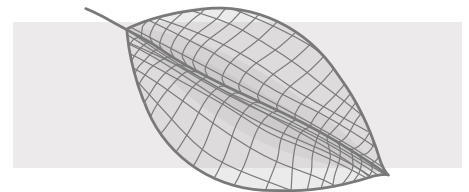

PRESERVED GREENERY

Preserved greenery maintains the appearance of live plants with less ongoing maintenance. While not every plant can be preserved, certain fronds and reindeer moss remain incredibly popular choices.

- VARIETY ● ○ ○ ○ ○
- DURABILITY ● ● ● ● ○
- INITIAL COST ● ● ● ● ○
- ONGOING COSTS ● ○ ○ ○ ○

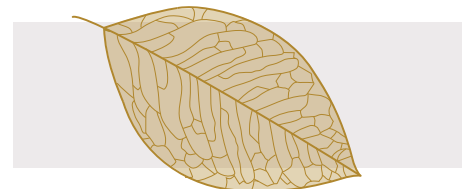

LIVE GREENERY

Live greenery has a soothing presence and invokes a greater sense of wellness and sustainability. Some conditions may limit the viability of live greenery, as it is climate-sensitive and requires ongoing care.

- VARIETY ● ● ● ● ○
- DURABILITY ● ○ ○ ○ ○
- INITIAL COST ● ● ● ● ○
- ONGOING COSTS ● ● ● ● ○



ROPE BUCKET

SPECIFICATIONS

| | |
|-----------------------|--|
| PRODUCT ID | BIO-RBK-001 |
| CONTENT | ThermaLeaf® Inherently Fire Retardant Foliage, Soundcore® Recycled PET Acoustic Felt |
| DURABILITY | Impact resistant, shock absorbant |
| WEATHERING | Non-deteriorating, non-hygroscopic, colorfast |
| MAINTENANCE | Clean with vacuum or light dusting |
| WARRANTY | Comes with industry-leading standard warranty |
| ENVIRONMENTAL | LEEDv4, VOC free, 100% recyclable, non-toxic, non-allergenic, anti-microbial |
| INSTALLATION | Plantscape Installation Systems are product specific |
| ACOUSTICS | Provides acoustic dampening |
| FLAMMABILITY | ASTM E84: Class A |
| SUSTAINABILITY | Made from 60% recycled content and is 100% recyclable |



ROPE BUCKET

COLORWAYS

SOUNDCORE® RECYCLED PET ACOUSTIC FELT



SNDI05
Sand Dollar

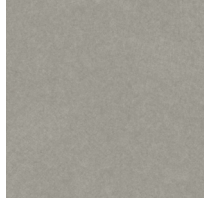

SNDI31
Abalone

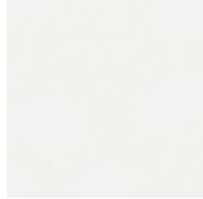

SND037
Paper



SNDI30
Buckskin



SNDI25
Chinchilla

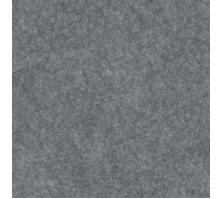

SND034
Granite Peak

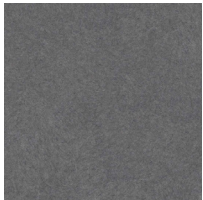

SNDI26
Wolfhound



SNDI03
Storm Cloud

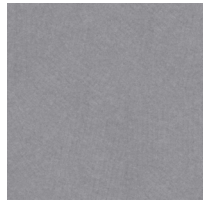

SNDI18
Anchor

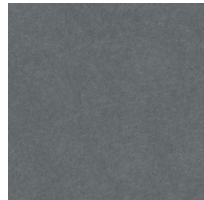

SNDI15
Mako

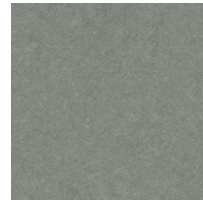

SNDI29
Dried Thyme



SNDI07
Grasshopper

ELEMENTS VENEERED RECYCLED PET ACOUSTIC FELT

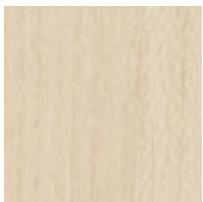

ELM326
Soft Maple

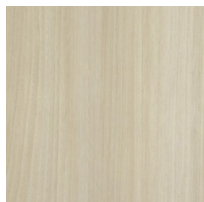

ELM311
Soft Elm

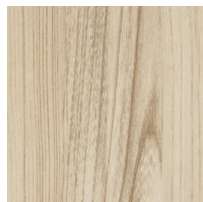

ELM325
Rough Elm

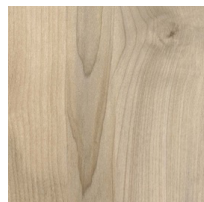

ELM329
Gray Cherry



ELM334
Greige Walnut



ELM337
Rosy Elm

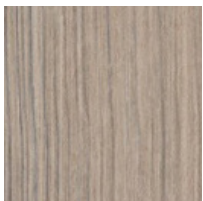

ELM338
Straight Teak

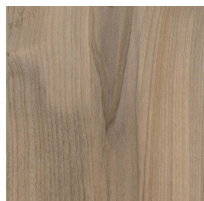

ELM341
Cotton Candy

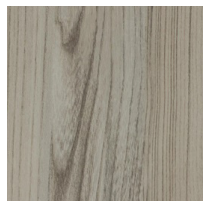

ELM316
Greige Elm

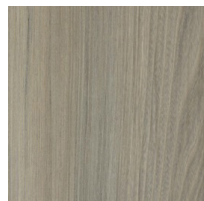

ELM318
Olde Gray

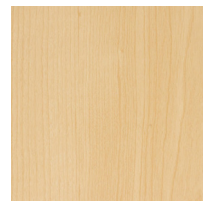

ELM410
Maple

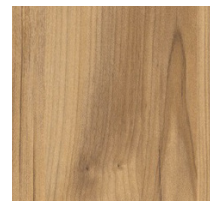

ELM343
Caramel Coffee

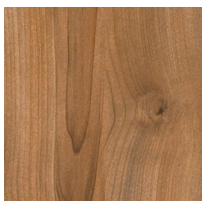

ELM344
Rustic Cherry

ROPE BUCKET

OUR MISSION



CELEBRATE NATURE THROUGH DESIGN

For over forty-five years, our mission has been to reconnect people with the experience of the natural world. For many, opportunities to enjoy lush environments are rare, and that lack of connection can take a toll on your sense of well-being. We are leading the charge into the future of biophilic design by creating transportive green experiences within everyday environments that harmonize with the context of your space.

We continue to innovate in our industry, designing the most botanically accurate, safest, and most durable replica greenery commercially available. Our project portfolio spans 75+ countries around the world, and we remain one of the top competitors in commercial greenery.

